

PinCH Tutorial 1

Welcome! The PinCH team of the Lucerne University of Applied Sciences and Arts offers tutorials for the PinCH software to present to you the possibilities of the software and how to use it. In five tutorials, you will learn the basics of using PinCH for energy and cost optimization in industrial processes:

PinCH Tutorial 0	Quick Overview
PinCH Tutorial 1	Continuous Production Plant
PinCH Tutorial 2	Production Plant with Multiple Operating Cases
PinCH Tutorial 3	Discontinuous Production Plant
PinCH Tutorial 4	Integration of Thermal Energy Storage

The tutorials are sequential. If you are using PinCH for the first time, we recommend that you start with [Tutorial 0](#) entitled "Quick Overview".

The tutorials and the associated "finished" PinCH files can be downloaded from the website www.pinch-analyse.ch. The tutorials can be solved with the trial version of PinCH (full version, but limited to eight process streams). To obtain the trial version, please send an E-Mail to pinch@hslu.ch.

The tutorials are available in German, English and French. The labels in process flow charts and the names of processes, streams, etc., as well as software-related terms, are always kept in English. The used currency is Euro.

Energy and cost optimization with PinCH is carried out in [10 Steps](#). You will find an overview of the [10 Steps](#) and a list of symbols and abbreviations in [Tutorial 0](#).

The tutorials focus on using the PinCH software. It is assumed that you are familiar with the basic principles of the pinch analysis. We recommend the following books as an introduction or for a deeper insight into the pinch method:

- F. Brunner, P. Kruppenacher: Einführung in die Prozessintegration mit der Pinch-Methode – Handbuch für die Analyse von kontinuierlichen Prozessen und Batch-Prozessen. Swiss Federal Office of Energy SFOE, 2017 (available from www.pinch-analyse.ch)
- R. Smith: Chemical Process Design and Integration. 2nd Edition, John Wiley & Sons, 2016; Pinch Analysis from Chapter 15 onwards (ISBN 9781119990130)
- I. C. Kemp: Pinch Analysis and Process Integration – A User Guide on Process Integration for the Efficient Use of Energy. 2nd Edition, Elsevier Butterworth-Heinemann, 2007 (ISBN 978-0-7506-8260-2)

You have the [PinCH Tutorial 1](#) in front of you. The tutorial involves the analysis and optimization of a production process in the chemical industry that is operated continuously. The content of [Tutorial 1](#) is structured as follows:

Contents

I. Introduction Tutorial 1	2
II. Case Study: Chemical Process	3
III. 10 Steps in PinCH	7
IV. Optimized Process	25

I Introduction [Tutorial 1](#)

Learning Goal: Complete a Pinch Analysis of a Continuous Process with [PinCH](#).

Duration: 2-3 Hours

For the introduction to the software we will consider in [Tutorial 1](#) a continuous process. The case study has been simplified for didactical reasons. This tutorial guides you through the pinch analysis so you can learn the operation and capabilities of the software. To optimize the energy and costs of a continuous process you go through the following steps ([Steps 2, 7 and 9](#) are not needed for this case study):

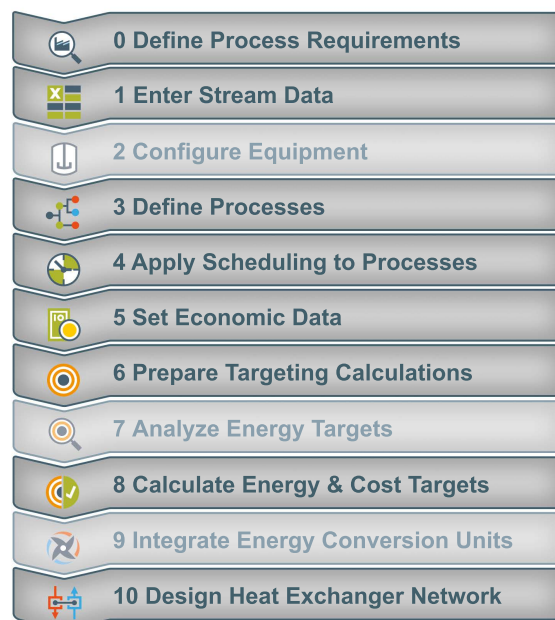

Figure 1: Workflow steps in [PinCH](#) for the optimization of a continuous process

The PinCH team of Lucerne University of Applied Sciences and Arts wishes you a successful and instructive experience!

II Case Study: Chemical Process

Process Description

In a production plant of the company Feinchemie AG two reactants (Reactant A and Reactant B) are combined together in a reactor to produce a base chemical. Next, the resulting Reaction Mixture is separated into Product C and Recycling Stream in a distillation column. The Reaction Mixture is pre-heated before entering the column and the Product C and the Recycling Stream are cooled after leaving the column. The process schema of the plant is shown in Figure 2. All relevant data necessary for the pinch analysis are summarized in Table 1.

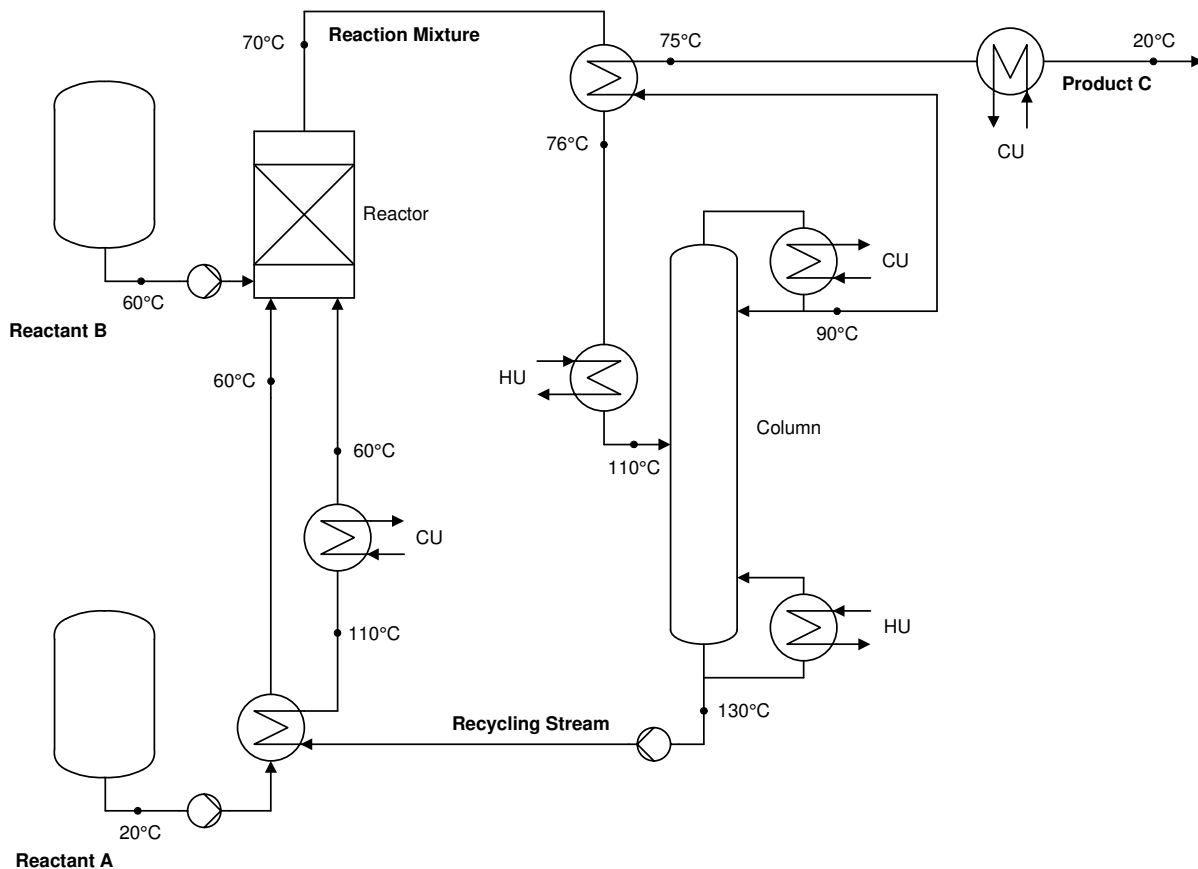

Figure 2: Process schema of the existing production plant

Table 1: Process streams

Process Stream	\dot{m} [kg/s]	c_p [kJ/(kg K)]	α [W/(m ² K)]
Reactant A	1.0	2.5	1'000
Reactant B	0.5	1.9	1'000
Reaction Mixture	4.0	2.4	1'000
Product C	1.5	2.5	1'000
Recycling Stream	2.5	2.0	1'000

Scheduling

The production plant is operated continuously for 7'000 h/a. In Figure 3 is shown the Gantt chart of the production plant.

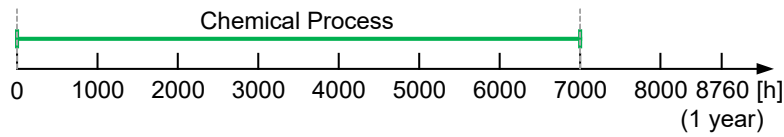

Figure 3: Gantt chart

Utilities

For the heating and cooling of the process streams, the **Utilities** as displayed in Table 2 are available. As hot utility (HU) heating steam is used. The steam is present in a saturated state, hence the inlet and outlet quality x and the pressure p are indicated. As cold utility (CU) cooling water is used and is prepared using a chiller.

Table 2: Utility data

Utility Stream	T_{in} [°C]	T_{out} [°C]	p [bar(a)]	α [W/(m ² K)]	c [€/MWh]
Heating Steam (HU)	$x=1$	$x=0$	4	5'000	70
Cooling Water (CU)	6	12	3	2'000	40

The yearly operating costs C_{Op} [€/a] correspond to the energy costs C_{En} [€/a] under the assumption of negligible maintenance and personnel costs. The yearly operating costs are calculated according to equation 1. In this equation τ [h/a] is the yearly operating hours, \dot{Q} [kW] is the demand for hot (HU) and cold utility (CU) and c [€/MWh] is the specific cost for either the hot or cold utility.

$$C_{Op} = C_{En} = \tau \cdot (\dot{Q}_{HU} \cdot c_{HU} + \dot{Q}_{CU} \cdot c_{CU}) \quad (1)$$

The existing plant requires $\dot{Q}_{HU} = 326$ kW HU and $\dot{Q}_{CU} = 456$ kW CU. This results in annual operating costs of $C_{Op} = C_{En} = 287'420$ €/a.

Investment Costs

In our example only the cost C_{HEN} for the heat exchangers (HEX) for the heat recovery (HR) and for the utility are considered. If an additional Energy Conversion Unit (ECU), such as a combined heat and power unit or a heat pump, is integrated into the process, then the associated investment costs C_{ECU} must also be included in the cost calculation. In this tutorial, there are no ECUs considered so the following is used to calculate the total investment costs C_{Inv} :

$$C_{Inv} = C_{HEN} + C_{ECU} \quad \text{with} \quad C_{ECU} = 0 \quad (2)$$

The costs for the heat exchanger network (HEN) are defined as the sum of the individual HEX cost C_{HEX} . In PinCH the HEN costs are calculated as follows:

$$C_{HEN} = \sum_{HEX} C_{HEX} = \sum_{HEX} \left(C_0 + C_b \cdot \left(\frac{A_{HEX}}{A_b} \right)^m \right) \quad (3)$$

In this case study the following cost parameters are applied:

- Fixed costs for the heat exchanger (independent from the heat exchanger area): $C_0 = 0$ €

- Base cost for a reference heat exchanger ($b = \text{base}$): $C_b = 110'000 \text{ €}$
- Heat transfer area of the reference heat exchanger: $A_b = 100 \text{ m}^2$
- Degression Factor: $m = 0.71$

Equation 3 describes accordingly the costs of a HEX with a heat transfer area A based on a reference HEX with the base cost of $C_b = 110'000 \text{ €}$ and a given area of $A_b = 100 \text{ m}^2$.

The investment costs also include the cost for installation and the cost to put the HEX into operation.

In PinCH the HEX area A is calculated according to equation 4. The overall heat transfer coefficient k is calculated using the two thin film heat transfer coefficients α under the assumption of negligible thermal resistance of the HEX wall and the average temperature difference ΔT_m (see references on page 1).

$$A = \frac{\dot{Q}}{k \cdot \Delta T_m} \quad \text{with} \quad \frac{1}{k} = \frac{1}{\alpha_1} + \frac{1}{\alpha_2} \quad (4)$$

Total Costs

The yearly total costs $C_{tot} [\text{€/a}]$ is calculated from the combination of the yearly investment cost and the yearly operating cost. Where a is the annuity factor.

$$C_{tot} = a \cdot C_{Inv} + C_{Op} \quad \text{mit} \quad a = \frac{Z \cdot (1 + Z)^n}{(1 + Z)^n - 1} \quad (5)$$

In this case study the following value are used:

- Interest Rate: $Z = 6 \%$
- Pay off Period: $n = 3 \text{ a}$

Since we are considering an existing production plant (i.e retrofit) and assume (i) that the plant has already been fully paid off and (ii) that no optimization measures have yet been implemented, only the operating costs are to be considered resulting in $C_{tot} = C_{Op} = 287'420 \text{ €/a}$.

Problem Formulation

In the existing process, measures for in-process heat recovery have already been implemented. By means of a pinch analysis the process is investigated to determine additional HR potential. PinCH offers you assistance in systematically developing the optimal solution. According to the guiding principle of pinch analysis **Targets before Design!**, the energy and cost targets will be calculated and used in designing a heat exchanger network to match these targets.



Step 0: Define Process Requirements

Before we begin entering data into PinCH, we want to determine the key information needed for a pinch analysis and in particular define the **process requirements**.

Additional information: A process requirement according to pinch analysis represents a necessary heating or cooling demand of a particular media (e.g. air, water, solvent, etc.). Typically it represents a mass stream with a flow rate \dot{m} , a specific heat capacity c_p , as well as an inlet and outlet temperature (T_{in} and T_{out}).

The basis for defining the process requirements is the extraction of process information from process flow sheets and equipment descriptions, operating documentation, etc. To learn more about this critical task, we recommend reviewing the guidelines for data extraction as given in the references on page 1.

Try and extract the relevant data for the pinch analysis from the plant equipment description and the related process flow sheet on page 3 and formalize the process requirements. Note that for operational reasons Feinchemie AG does not want to include the evaporator and condenser of the column in the pinch analysis.

The result of the data extraction are the process requirements shown in Table 3 and in Figure 4.

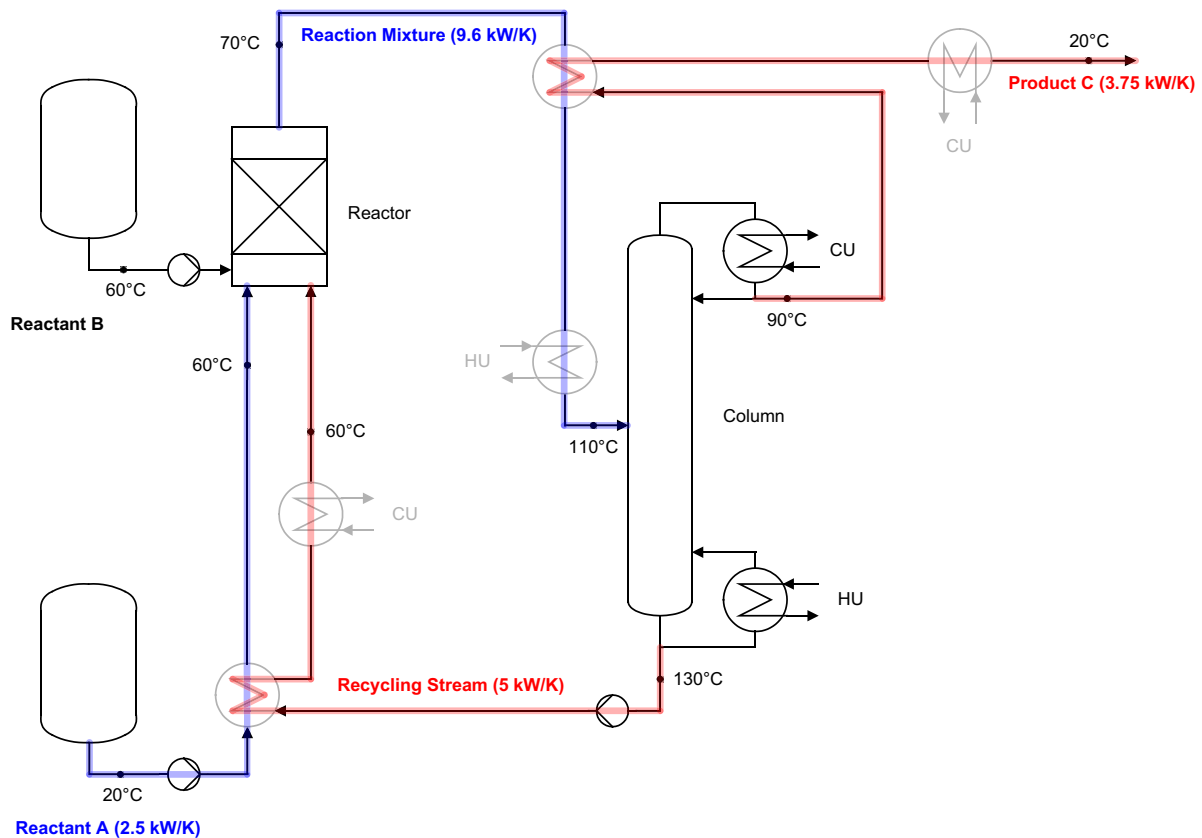

Figure 4: Process requirements

Table 3: Process requirements

Process Stream	T_{in} [°C]	T_{out} [°C]	α [W/(m ² K)]	\dot{m} [kg/s]	c_p [kJ/(kg K)]
Reactant A	20	60	1'000	1.0	2.5
Reaction Mixture	70	110	1'000	4.0	2.4
Product C	90	20	1'000	1.5	2.5
Recycling Stream	130	60	1'000	2.5	2.0

Additional information: Since Reactant B is already at 60 °C as it flows into the process, it does not need to be heated. Therefore, it is not a process requirement.





III 10 Steps in PinCH

Let's go!

To begin the tutorial start the software [PinCH](#). Before continuing with the actual project, it is recommended to check the basic settings in [PinCH](#) and adjust them if necessary. In this tutorial the costs are to be given in €, requiring that the currency has been changed in the Settings. In addition, the units kW/MWh will be used. How this is done is reviewed in the [Tutorial 0](#).

This tutorial follows closely the [10 PinCH Steps](#) (see [Tutorial 0](#)). In [Steps 1-5](#) are shown how to input and configure the process relevant data in the [Project Explorer](#). In [Steps 6-10](#) the system is optimized in the [Target Explorer](#).

Create a new Project and change the default name to "Chemical Process" as follows:

-  [File](#)  [New Project](#)
-  Select in the Project Explorer [New PinCH Project](#)
-  Select the F2-key
-  Change the project name to "Chemical Process"





Step 1: Enter Stream Data

The entry of process stream data is necessary to specify the process requirements identified during the data extraction. Enter this data into the [Process Stream Table](#).

Open the Process Stream Table by clicking the

-  Tab [Process Stream Table](#)



It is also possible by

-  Double clicking on the Process Stream Table icon  in the Project Explorer

To create new process streams click on

-  the icon 

As an alternative the following can be done:

-  right click on the empty area of the Process Stream Table
-  select [Add Continuous Process Stream](#) (see [Figure 5](#))

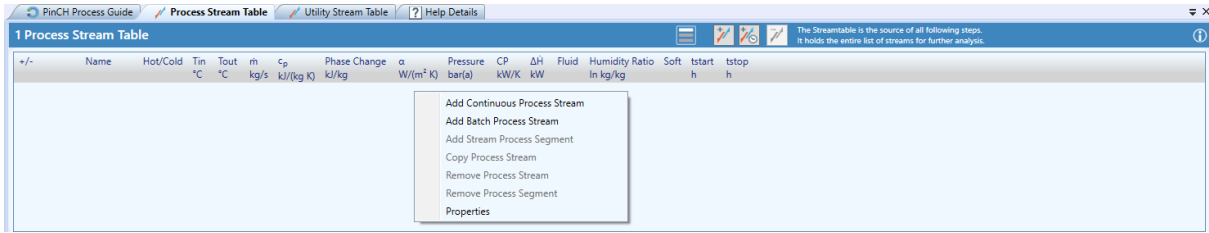

Figure 5: Adding a continuous stream in the Process Stream Table

Rename the process stream and change the default process stream data:

- ☞ Select [New Process Stream 1](#)
- ☞ Enter a suitable name for the process stream, e.g. "Reactant A".
- ☞ Select the additional cells to change the default values for T_{in} , T_{out} , \dot{m} , c_p and α . Observe that you have used the correct units and related quantities.

Note: You can also use the tab key to navigate from cell to cell.

Did you notice that upon entering a cold stream to be heated that the arrow in the column Hot/Cold changes to a blue arrow? In pinch analysis streams to be heated are cold streams and those to be cooled are hot streams.

Note: You can delete a process stream by doing the following:

- ☞ select the desired stream to delete and click on

A possible alternative is:

- ☞ Right click on the stream to be deleted
- ☞ Select [Remove Process Stream](#)

The completed process stream table should look as follows:

+/-	Name	Hot/Cold	T_{in} °C	T_{out} °C	\dot{m} kg/s	c_p kJ/(kg K)	Phase Change kJ/kg	α W/(m ² K)	Pressure bar(a)	CP kW/K	ΔH kW	Fluid	Humidity Ratio In kg/kg	Soft	tstart h	tstop h
	Reactant A	↙	20	60	1	2.5	-	1000	-	2.5	100	Simple	-	<input type="checkbox"/>	-	-
	Product C	↗	90	20	1.5	2.5	-	1000	-	3.75	262.5	Simple	-	<input type="checkbox"/>	-	-
	Recycling Stream	↗	130	60	2.5	2	-	1000	-	5	350	Simple	-	<input type="checkbox"/>	-	-
	Reaction Mixture	↙	70	110	4	2.4	-	1000	-	9.6	384	Simple	-	<input type="checkbox"/>	-	-

Figure 6: Process Stream Table

Note: In the Fluid column, different fluids can be selected so that the specific heat capacity (c_p) and (if relevant) the heat of evaporation (phase change) are automatically calculated. In this case, the pressure must be defined to allow the underlying thermodynamic equations to be solved. The Humidity Ratio column is to be used only for the humid air fluid. If the column Fluid "Simple" is listed, all data can be entered manually. In the [Soft](#) column, you can define a soft stream and in the [tstart](#) and [tstop](#) columns you can define the timing of a batch process stream which for this example will not to be used.

The Process Stream Table is dynamic and automatically updates the necessary data as soon as enough information is available to satisfy the degrees of freedom. For example, PinCH calculates by default the heat capacity flowrate CP and the required enthalpy change. You can also enter other combinations of data, such as T_{in} , T_{out} , c_p and $\Delta\dot{H}$. In this case the mass flow \dot{m} is calculated. The green cells indicate those values that are calculated. The heat capacity flowrate CP is the product of the mass flow rate and the specific heat capacity.

Note: Process streams can be imported from an Excel table:

 File  [Import Stream Table](#)

In order to ensure the correct formatting of the table is used, it is recommended to first export an empty Process Stream Table from PinCH that you can edit in Excel and then import again into PinCH.



 File  [Export Stream Table](#)

In a second step, the existing Utilities used in the process (heating and cooling mediums) must be entered into the [Utility Stream Table](#). A process requires at least two Utilities: a default Hot Utility and default Cold Utility to ensure all necessary information can be calculated (i.e. the HU is "hot enough" and the CU is "cold enough") and the energy balance is closed.



To open the Utility Stream Table, do the following:

 Select the tab Utility Stream Table on the main workbench.

As alternative you can open the Utility Stream Table from the Target Explorer:

 Double click on the Utility Stream Table icon  in the Target Explorer

To add a new utility stream, do the following:

 Select the icon 

 Rename the utility streams and change the default values according to the necessary utility information in Table 2 on page 4.

As in the Process Stream Table, you can select different fluids in the Fluid column. As a utility, water (heating steam, cooling water) or refrigerants (R134a, R717, etc.) are often used. Condensing or evaporating media can be described by the quality x at the inlet and outlet. For this example, select "Water" for the Hot and Cold Utility in the column Fluid. The condensing Hot Utility heating steam considers only the condensation energy requiring that x_1 (100 % dew point steam) is entered in the column T_{in} and x_0 (0 % bubble point water) in column T_{out} . A steam content of 50 % (wet steam) is represented by the quality $x_{0.5}$. Note also that the steam content can only be entered in the Fluid column after selecting "Water" ("Simple" and "Humid Air" is not applicable). Enter the specific energy costs (EUR/MWh) in the table.

Note: The utility costs are used later to calculate the yearly energy costs.

The completed Utility Stream Table should look as follows:

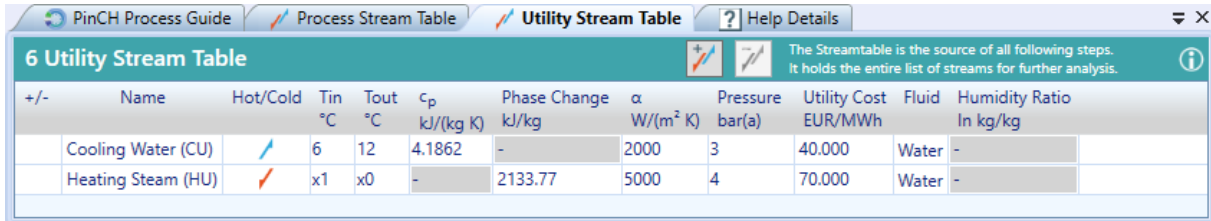

+/-	Name	Hot/Cold	Tin °C	Tout °C	c_p kJ/(kg K)	Phase Change kJ/kg	α W/(m ² K)	Pressure bar(a)	Utility Cost EUR/MWh	Fluid	Humidity Ratio In kg/kg
	Cooling Water (CU)	Blue arrow	6	12	4.1862	-	2000	3	40.000	Water	-
	Heating Steam (HU)	Red arrow	x1	x0	-	2133.77	5000	4	70.000	Water	-

Figure 7: Utility Stream Table



Step 2: Configure Equipment

In PinCH an **Equipment** represents either a physical pipe, canal or a tank in which at least one or more process requirements occur. There are many examples of heating and cooling requirements occurring in time dependent processes where the requirements do not exist at the same time (provided the process streams do not exist at the same time). By properly assigning process requirements that occur in the same piece of equipment, reuse of heat exchanger area can be properly accounted for by reducing the cost of the associated heat exchangers.

Additional information: For batch processes, Step 2 is an important consideration. Through the defining of equipment it is possible in PinCH to analyze the overlapping in time of consecutive batches for better heat recovery potential. Detailed information and practical examples related to assigning process streams to equipments can be found in the references on page 1.





In [Tutorial 1](#) it is not necessary to assign the process streams to specific equipment as in this example we are considering a continuous process. This step is reviewed in detail in [Tutorials 2](#) and [3](#).





Step 3: Define Processes

To enable the energetic optimization of industrial operations that have several spatially and technically independent pieces of equipment (and their associated heating and cooling demands), it is possible to define different processes. A single process is nothing more than a "cluster of process streams". Therefore, the definition of multiple processes allows different scenarios to be considered. For example, processes can be optimized separately as single independent processes or together in different groups. The optimization of the total site (i.e. all streams together) is also possible. An example of such a plant is shown in [Tutorial 2](#).

For this tutorial, the allocation of the process requirements defined in the Process Stream Table to different processes is not necessary. Use the automatically generated [Process 1](#) and rename it to "Chemical Process".

-  Select in Project Explorer [Process 1](#) (under BaseCase  Processes)
-  Press the F2-key
-  Change name to "Chemical Process"

Assign to the process "Chemical Process" the related process requirements.

-  Double click on [Chemical Process](#) (under BaseCase  Processes)
-  Select one of the required process streams in the Process Stream Table located in the upper half of the window



Note: Alternatively you can use Drag & Drop to assign the process streams to the selected process (i.e. from the upper table to the lower table). Several process streams can be selected by pressing the Ctrl key while selecting streams to assign to the process.

Complete this step for each of the process requirements to be assigned to the selected process. The fully defined process should look as follows:





The screenshot shows the PinCH software interface with two tables. The top table, '1 Process Stream Table', lists process streams with their properties. The bottom table, '3 Process Streams - Chemical Process', shows the streams assigned to a specific process.

+/-	Name	Hot/Cold	Tin °C	Tout °C	m kg/s	c _p kJ/(kg K)	Phase Change kJ/kg	α W/(m ² K)	Pressure bar(a)	CP kW/K	ΔH kW	Fluid	Humidity Ratio In kg/kg	Soft	tstart h	tstop h
	Reactant A	Hot	20	60	1	2.5	-	1000	-	2.5	100	Simple	-	<input type="checkbox"/>	-	-
	Product C	Cold	90	20	1.5	2.5	-	1000	-	3.75	262.5	Simple	-	<input type="checkbox"/>	-	-
	Recycling Stream	Cold	130	60	2.5	2	-	1000	-	5	350	Simple	-	<input type="checkbox"/>	-	-
	Reaction Mixture	Hot	70	110	4	2.4	-	1000	-	9.6	384	Simple	-	<input type="checkbox"/>	-	-

+/-	Name	Hot/Cold	Tin °C	Tout °C	m kg/s	c _p kJ/(kg K)	Phase Change kJ/kg	α W/(m ² K)	Pressure bar(a)	CP kW/K	ΔH kW	Fluid	Humidity Ratio In kg/kg	Soft	tstart h	tstop h
	Reaction Mixture	Hot	70	110	4	2.4	-	1000	-	9.6	384	Simple	-	<input type="checkbox"/>	-	-
	Recycling Stream	Cold	130	60	2.5	2	-	1000	-	5	350	Simple	-	<input type="checkbox"/>	-	-
	Product C	Cold	90	20	1.5	2.5	-	1000	-	3.75	262.5	Simple	-	<input type="checkbox"/>	-	-
	Reactant A	Hot	20	60	1	2.5	-	1000	-	2.5	100	Simple	-	<input type="checkbox"/>	-	-

Figure 8: Completely defined Chemical Process with the assigned Process Streams

Note: To remove a process stream from the selected process

 select the process stream in the lower table followed by selecting 

Alternatively you can

 Right click on the process stream to be removed and

 Select [Deassign Process Stream](#)



Step 4: Apply Scheduling to Processes

Schedules are necessary to define the time profile of the processes configured in [Step 3](#). This case study considers only a single continuous process requiring only the hours of operation to be given.

Additional information: In the case that more than one process is defined, multiple operating cases (MOC) can be defined in which different heating and cooling demands exist. As a result, the schedule for each process must be fully defined. More detailed information is provided in Tutorial 2 and 3. In the case of a batch process (discontinuous process streams), the equivalent to multiple operating cases

exist, but on a smaller time scale called Time Slices (TSs) for the process. The time profile of a batch process therefore requires additional information to be fully defined.

Returning to the case study: For a continuous process there is only one operating case and the definition of only the yearly operating duration is required. Any process downtime of the production equipment during the night or over the weekend does not have to be considered for this tutorial.

Open the tab [OC Schedule 1](#).

☞ Double click on [OC Schedule 1](#) (in Project Explorer under BaseCase ☞ Operating Cases Scheduling)

Enter the yearly operation duration in hours defined in the process description and in [Step 3](#).

☞ In the column [Timebase](#) select "Cont. Year"

☞ Select the cell [Duration](#)

☞ Change the value accordingly

The tab OC Schedule 1 shows our process defined to begin in calendar week 1 on Monday morning at 00:00 and for a duration of 7'000 h without interruption.

Note: The column [Production Campaign Start](#) defines the point in time, at which the process starts relative to the beginning of the year. In the column [Production Campaign End](#) is the point in time at which the process stops production. The [Gross Operation Time](#) shows the operational time of the process including interruptions (Difference between Production Campaign Start and Production Campaign End). The [Net Operation Time](#) shows how many hours the process is effectively in operation e.g. interruptions during the night, weekends, etc.) The Net Operation Time defines the total amount of time the process is in operation per year and is used to calculate the necessary energy cost.

For our case study the tab OC Schedule 1 should look as follows:

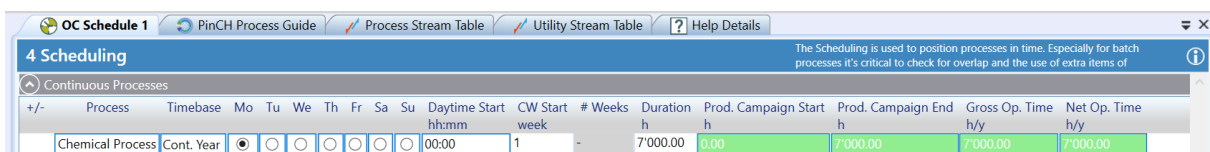

Process	Timebase	Mo	Tu	We	Th	Fr	Sa	Su	Daytime Start hh:mm	CW Start week	# Weeks	Duration h	Prod. Campaign Start h	Prod. Campaign End h	Gross Op. Time h/y	Net Op. Time h/y
Chemical Process	Cont. Year	<input checked="" type="radio"/>	<input type="radio"/>	<input type="radio"/>	<input type="radio"/>	<input type="radio"/>	<input type="radio"/>	<input type="radio"/>	00:00	1	-	7'000.00	0.00	7'000.00	7'000.00	7'000.00

Figure 9: Operating Cases Scheduling



Step 5: Set Economic Data

The configuration of economic data is required for the calculation of the yearly investment and yearly operating costs.

In [PinCH](#) the total investment costs for the heat exchangers is explained in section "Investment Costs" on page 4. Four sets of cost parameters can be defined:

- for a HEX between Process Streams
- for a HEX between HU and Process Streams
- for a HEX between CU and Process Streams

- for a HEX between Storage Intermediate Loops and Process Streams

Open the tab **Economic Data**.

☞ Double click on **Economic Data** (in Project Explorer under BaseCase ☞ Economic Data)

Change the economic data values for the Process Heat Exchanger Cost according to the supplied data.

☞ Select the cell

☞ Change the value

According to the process description, the heat exchangers for heating with steam (HU) and cooling with cooling water (CU) already exist. Therefore, the C_b -value for Hot und Cold Utility Heat Exchanger Cost can be set to zero. The available heat exchangers should be reused. The **Pay off period** and the **Interest rate** can be defined according to the specification.

Note: The costs for a HEX between a storage intermediate loop and a process stream (ISSP-HEX), Storage Tank Costs and Storage Media Costs are in this case study not necessary.

Additional information: Electricity costs, independent fixed costs as well as personnel and maintenance costs can also be given. Most important is the electricity cost that is used later when integrating different types of heat pumps. To determine the optimal ΔT_{min} ; however, this cost is not relevant as the additional operating cost is independent from ΔT_{min} . Under "Electric Power" a constant electrical power demand (Base Load, e.g. for pumps, fans, mixers) can be entered and considered in the operating costs as well.

The complete economic data definition should be as follows:

The screenshot shows the '5 Economic Data' window in PinCH. It contains several sections:

- Heat Exchanger Costs:**

$$C = C_0 + C_b (A/A_b)^m$$

$$A = \text{Heat Exchanger Area in m}^2$$

Type	Fixed Cost C_0 EUR	Base Cost C_b EUR	Base Area A_b m ²	Exponent m
Process Heat Exchanger Costs	0	110'000.0	100	0.71
Hot Utility Heat Exchanger Costs	0	0.0	100	0.71
Cold Utility Heat Exchanger Costs	0	0.0	100	0.71
ISSP Heat Exchanger Costs	0	110'000.0	100	0.71
- Storage: Tank Costs:**

$$C = C_0 + C_b (V/V_b)^m$$

$$V = \text{Tank Volume in m}^3$$

Storage	Fixed Cost C_0 EUR	Base Cost C_b EUR	Base Volume V_b m ³	Exponent m	Storage Type
FTVM	0	120'000.0	100	0.71	FTVM
Stratified	0	120'000.0	100	0.71	Stratified
- Storage: Media Costs and Media Properties:**

$$C = C_b \cdot m_{sm}$$

$$m_{sm} = \text{Mass of Storage Media in kg}$$

Media	Base Cost C_b EUR/kg	Density kg/m ³	α W/(m ² K)	c_p kJ/(kg K)
Water	0.0010	1000	2000	4.18789
Heat Transfer Oil	5.0000	800	1000	2.00000
- Amortisation Parameters:**

Pay Off Period: y Independent: EUR

Interest Rate: % Personnel: %/y Investment Costs

Annuity: 0.374 1/y Maintenance: %/y Investment Costs
- Electricity:**

Note: Utility Costs are set on Utility Stream Table

Electricity Cost: EUR/MWh Electric Power: kW

Figure 10: Economic Data

Your Project Explorer should now have the following structure:

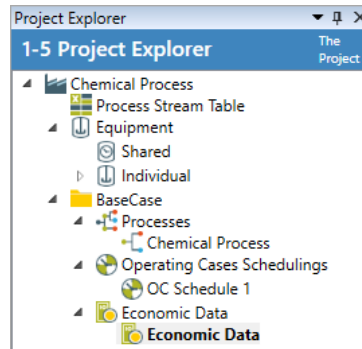

Figure 11: Project Explorer

Step 6: Prepare Targeting Calculations





After the completion of [Steps 1 - 5](#) all necessary process data and information as well as economic data for the pinch analysis is given. You can now calculate the energy and cost targets in the [Target Explorer](#) by creating first a so called [Target Group](#).

Additional information: A Target Group consists of the combination of (one or more) Processes, Utilities, Operating Case Schedule and economic data. Several scenario analyses can be completed using combinations of the data configured in Steps 1 - 5 resulting in different energy and cost targets. If there is only one Hot or Cold Utility defined, PinCH assigns them automatically to the Target Groups. The same is valid for the processes if there is only one process defined.

The creation of a Target Group:

-  Right click on BaseCase in Target Explorer
-  Select [Add Target Group](#)

If not automatically done, assign to the Target Group the process "Chemical Process" defined in [Step 3](#):

-  Double click on [Target Group 1](#)
-  Right click on Processes
-  Select [Assign Process](#)  "Chemical Process"

If not automatically done, assign to the Target Group as a minimum one Hot and one Cold Utility as default:

-  Right click on Utilities
-  Select [Assign Utility Definition](#)  Hot Utility (repeat for Cold Utility)

Note: In order to reassign for the "Target Group 1 (Economic Data, OC Schedule 1)" a different Operating Cases Schedule or set of Economic Data, the following must be completed:

-  Right click on the Target Group
-  Select [Reassign Operating Cases Schedule / Reassign Economic Data](#)

Each command is possible only when, in the Project Explorer, a second Operating Cases Schedule and a second set of Economic Data was added.

Your Target Explorer should now have the following structure:

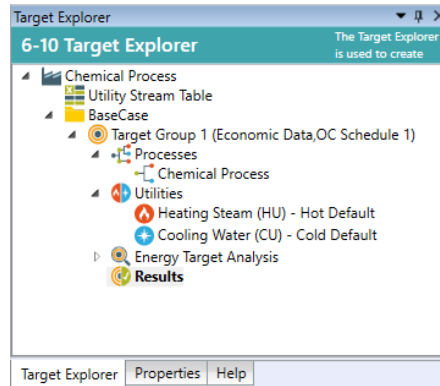

Figure 12: Target Explorer



Step 7: Analyze Energy Targets

Once the preparations in [Step 6](#) are complete, all the necessary preparations are finished for the calculation of the energy and cost targets. Before we calculate these results in [Step 8](#), we can use the tool [Energy Targeting Analysis](#) to comprehensively analyze the HR potential for the considered scenario (our Target Group).

Additional information: The Energy Target Analysis Tool enables among other things the investigation of the influence of the individual processes on the total HR potential, where multiple processes are operated at the same time in parallel. In addition, for batch processes, an analysis of direct and indirect HR potential can be done. The Energy Target Analysis offers much more and is especially helpful for complex systems, where multiple operating cases exist that must be optimized.

For our case study, there is only a single continuous process with one Operating Case, so a detailed analysis in [Step 7](#) is not necessary.





Step 8: Calculate Energy & Cost Targets

A key aspect of pinch analysis is the calculation of energy and cost targets before investigating individual HR measures.

Note: The main principle in pinch analysis is [Targets before Design!](#)

In [Step 8](#), [Targeting](#) is done to determine the optimum quantities for the utilities, the HR potential, the installed heat exchanger area, the number of heat exchangers to install and the related total costs.

Start the Targeting calculation:

-  Right click on [Results](#) node
-  Select [Calculate Target Result with...](#)  [Separate Design](#)

The automatically opened tab [Sep. Design 1_1](#), see [Figure 13](#), encompasses the following information windows:

- **Time Charts:** The Overall Gantt Chart shows the time profile of the considered process over a year. The OC Gantt Chart shows for the chosen Operating Case (OC) a time profile of the process over a basis of one week.
- **OC Charts:** Based on the different OC Charts it is possible to investigate the potential for energetic and economic optimization of the given Operating Cases.
- **OC Data:** Here the most important results are shown in tabular form.

In this tutorial, we will concentrate on the essential charts and figures for our case study.

Since we want to consider a continuous process and thus only one operating case, the time charts are not to be considered. You can hide them to be able to focus on the results and OC Charts.

 Uncheck the check boxes **Processes** and **OC's**

In addition, the window size can be changed by shifting the edge of each window manually. You can, for example, enlarge the window for OC Charts and thereby make the window Time Charts smaller.

 Place the mouse over the upper edge of the window OC Charts (a double arrow is shown)

 Click and drag the window edge upwards

In the window OC Charts we now want to analyze the chart **CC** (Composite Curves) and **Costs** (see Figure 13).

 Activate the check box **Costs** and deselect the **GCC** (Grand Composite Curve) check box

The Hot and Cold Composite Curves are shown in the figure **Composite Curves** ($T, \Delta\dot{H}$ chart). Within the range, where the two curves overlap, process-internal HR is possible. The minimum heating and cooling requirements (HU / CU) can be displayed graphically.

 Right click in the chart Composite Curves

 Select **Display Utilities**

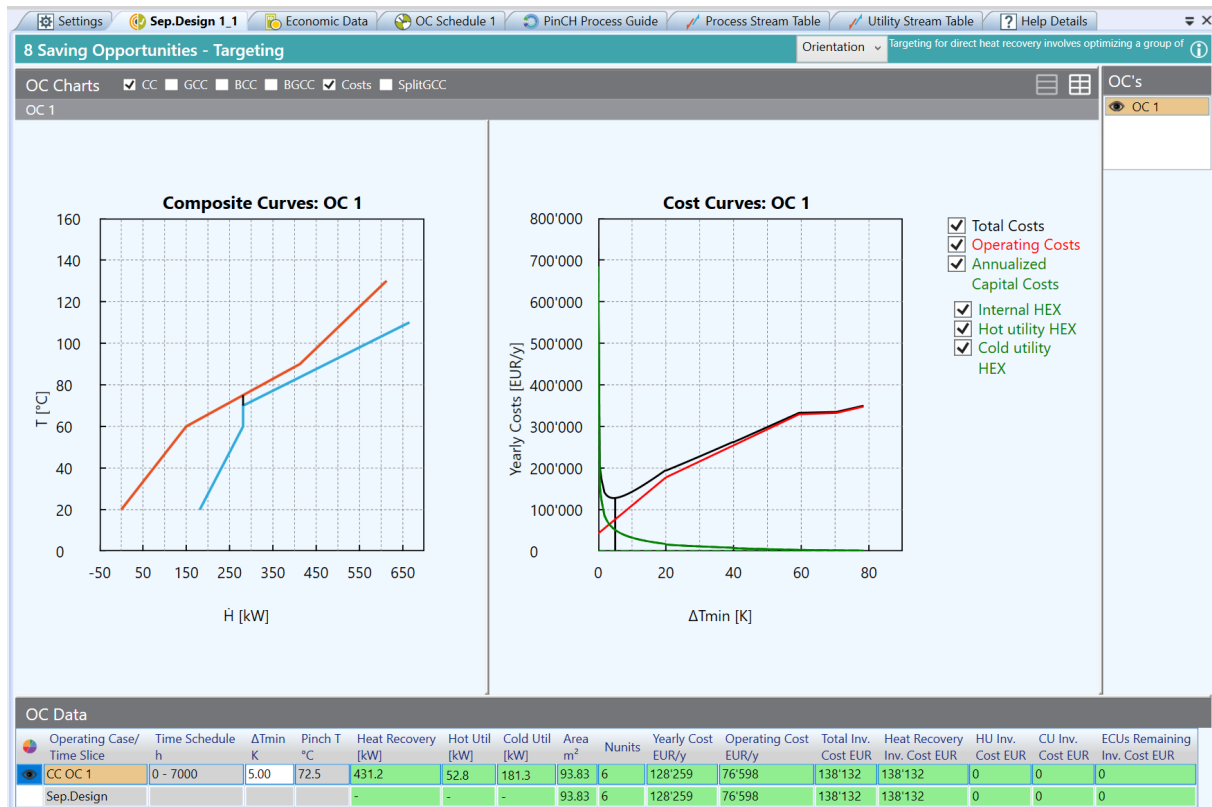

Figure 13: Composite Curves (red: hot CC, blue: cold CC), Cost Curves and OC Data

The position at which the vertical distance between the two composite curves is a minimum is defined as the **Pinch Point**. Importantly, this minimum temperature difference can be changed by shifting left or right the Cold Composite Curve. PinCH automatically calculates the energy and cost items. Whether you move the curve to the left or right the annual total costs will increase and observe that the software has already determined the optimal minimum temperature difference $\Delta T_{min,opt}$ automatically based on the cost curve (see black curve and the table OC Data on Fig. 13).

Additional information: The optimization of the minimum temperature difference is called **super-targeting**. Annual total costs are a function of the minimum temperature difference. This function is displayed graphically in the chart Cost Curve. With an increase in the minimum temperature difference, the operating costs are larger as less heat recovery can be achieved. At the same time, however, the annualized capital costs (green, solid curve) decrease, as the area of the heat transfer equipment becomes smaller. PinCH automatically calculates the total costs (black curve) from which the minimum temperature difference can be determined.

The energy and cost targets can be read directly from the OC Data table. The optimal temperature difference is $\Delta T_{min,opt} = 4.57$ K. Round this value due reasons of simplicity to $\Delta T_{min,opt} = 5$ K. This value results in the target value for the optimal amount of **Heat Recovery (HR)** of 431 kW. The optimal amount of Hot Utility is 53 kW and 181 kW for the Cold Utility. The minimal yearly total costs (annualized investment and operating costs) is ca. 128'000 €/a.

Finally we consider the **GCC** (Grand Composite Curve):

Activate the check box **GCC** and deactivate **CC** and **Costs**

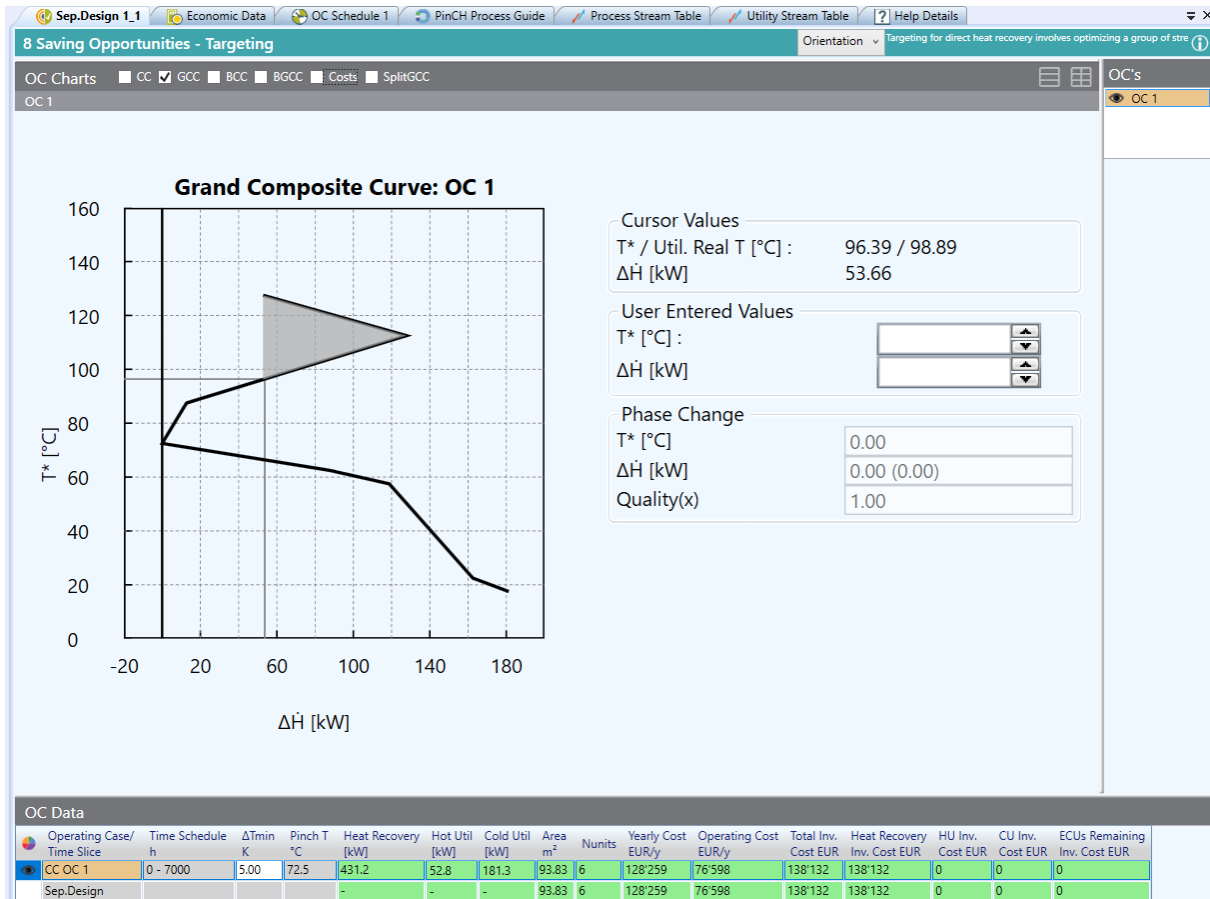

Figure 14: Grand Composite Curve

In our example, a so called **Pocket** exists above the pinch, see Figure 14. In the temperature region of the pocket neither external heating nor external cooling is necessary. The result based on this pocket is that HU can be lowered to $T = 99\text{ }^{\circ}\text{C}$.

Note: Due to its characteristics, the GCC is an excellent tool for investigating further potential for optimization with respect to the utility supply system, see references on page 1.

You can view the heat supply below the pinch by entering the temperature you are interested in under the heading T^* (shifted temperature) in the group **User Entered Values**. It should be noted that T^* depends on the T (real temperature) for placed Utility streams as follows:

- Above the Pinch: $T^* = T - \Delta T_{min}/2$
- Below the Pinch: $T^* = T + \Delta T_{min}/2$

In our case study the following conclusions can be made: Below the pinch point, at an interesting temperature region ranging from $20 - 72.5\text{ }^{\circ}\text{C}$, the process has approximately 180 kW heat surplus which can not be used in HR (so called waste heat). At this point it would be interesting to extend the system boundary for the pinch analysis and to investigate other unused heat sinks the production process could use (Total Site Analysis).



Step 9: Integrate Energy Conversion Units

In many industrial processes, the heating and cooling requirements remain high despite the heat recovery. In these cases, it is worth checking the integration of an [Energy Conversion Unit \(ECU\)](#). An ECU can, on one hand, be a heat engine, whose waste heat is used as heat in the process and thus replaces the Hot Utility. In most cases, the mechanical energy of the heat engine is converted into electrical energy (e.g. CHP) in a generator. On the other hand, an ECU can also be a power heat engine which "lifts" heat to a higher temperature level by means of electrical energy (e.g. heat pump). The high-quality heat is again used to replace Hot Utility.

Pinch analysis is an excellent tool to analyze the profitability of the integration of an ECU. The correct integration of a heat pump, a mechanical or thermal vapor recompression unit and combined heat and power (CHP) can be modeled in [PinCH](#) to optimize (and thus reduce costs) the energy supply.

The integration of a heat pump would be possible in this process; however, for this introduction tutorial we will not consider it.



Step 10: Design Heat Exchanger Network

Congratulations! You have successfully completed targeting as the basis for an energetic and economic optimization of the process. Now a crucial question arises: *How should the energy and cost savings be realized in practice?* With the help of [PinCH](#), the engineer can develop a [Heat Exchanger Network \(HEN\)](#). The HEN is less complex than a typical process flow chart, but it shows which process streams should be connected with each other and in which order. With this basis, an optimized system design can be developed.

In this example, we will create a so called [MER HEN \(Maximum Energy Recovery Heat Exchanger Network\)](#).

 Right click on the [Sep. Design 1_1](#) in Target Explorer

 Select [Add HEN...](#)  [Add MER HEN](#)

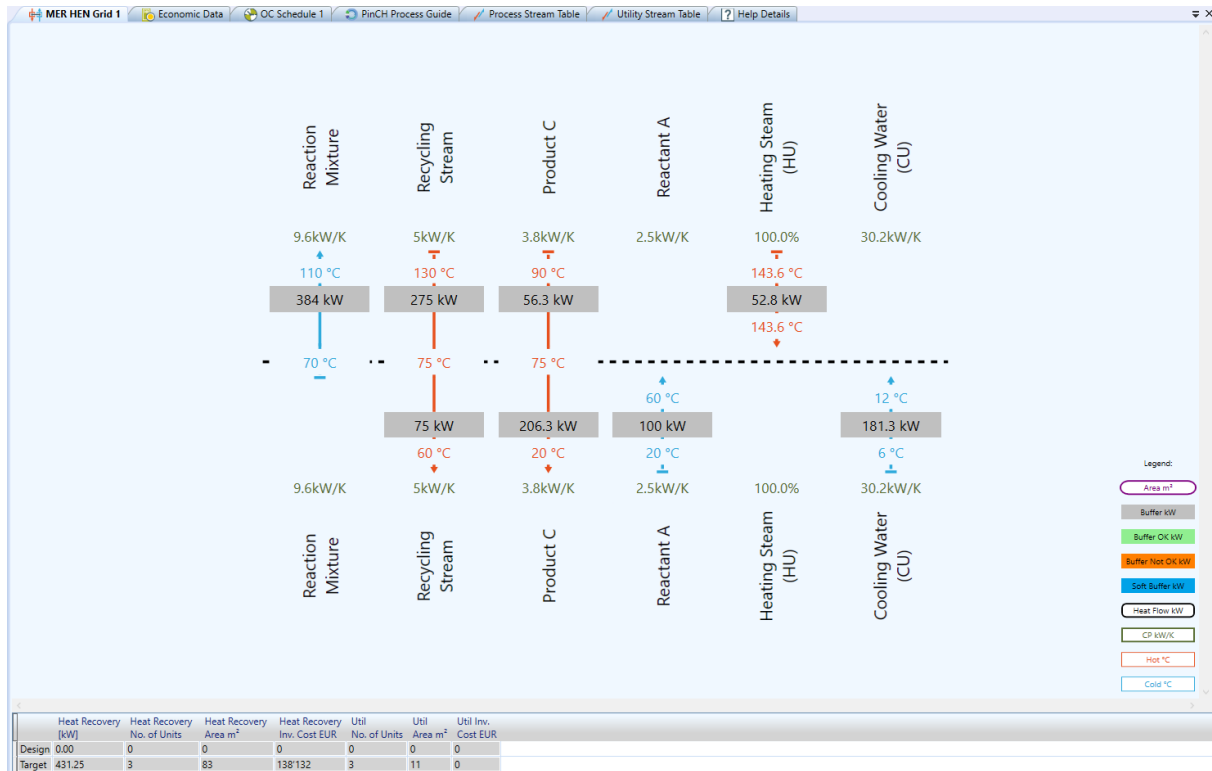

Figure 15: Empty MER HEN Grid

The new tab **MER HEN Grid 1** will appear. When designing a HEN, the individual process streams are considered. The directions of the arrows and the colors of the streams displayed in the MER HEN indicate whether they need to be heated (blue) or cooled (red). The values of the heat capacity flow rate (CP) are noted below or above the names of the associated stream. You can reposition each stream horizontally by dragging and dropping the stream names.

Additional information:

Within the MER HEN no violation of the three pinch main rules is allowed (no CU above the pinch point, no HU below the pinch point as well as no heat transfer across the pinch point). The MER HEN is bound strictly to the pinch temperature and is divided into two subsystems above and below the pinch. It is not possible to link the streams across the dashed line defining the pinch and thus no heat transfer over the pinch can occur. In addition, Hot Utility is available only above and Cold Utility only below the pinch. The design ensures that when creating the MER HEN the **three pinch main rules** are not violated (see references on page 1)

Let us first consider the subsystem below the pinch. According to the design rules for creating a MER HEN (see references on page 1), we want to start with the stream with the largest heat capacity flow rate (the largest CP) that goes in the direction towards the pinch. In our example, this is the stream Reactant A ($CP = 2.5 \text{ kW/K}$), whose heating requirement we want to completely satisfy in a heat exchanger that is as large as possible. The stream Product C ($CP = 3.8 \text{ kW/K}$, exact is $CP = 3.75 \text{ kW/K}$, the shown vales are rounded) is suitable for this, which has sufficient heat. To create a heat exchanger, we need two so-called Heater/Coolers.

If you position the mouse on the HEN a horizontal grey line is shown. By clicking on the line a row is added in the HEN. (see Figure 15)

- ☞ To add a Heater/Cooler click on to the blue line of stream Reactant A
- ☞ To add a Heater/Cooler click on the red line of the stream Product C

The Heater/Coolers are displayed as shown in Figure 16. In the middle of the left oval is shown the HR heat flow (in kW) and in the right oval the necessary heat exchanger area (in °C).



Figure 16: Heat exchanger with two Heater/Coolers

Connect the two Heater/Coolers:

- ☞ On the curve of either heat flow entry oval click to begin the connection (the curve is highlighted by a mouse hover).
- ☞ Using the pressed mouse button, drag the connection to the other Heater/Cooler
- ☞ Use the [Tick Off Rule](#) (Double click on the heat flow cell of a Heater/Cooler, see references on page 1)

By double-clicking, the maximum possible power of the heat exchanger is calculated (without violating the three main pinch rules and without neglecting the minimum temperature difference). You can also manually specify the heat transfer performance by entering the desired heat flow in the corresponding field of a Heater/Cooler and confirm with Enter.

Note: The heat flow listed in the buffer boxes (in kW) indicates the amount of heat that must be supplied or removed until it reaches the required final temperature. If a stream exists both above and below the pinch, it must meet its requirements above and below the pinch separately.

To complete the MER HEN in the subsystem below the pinch, we link the two hot streams with the Cold Utility.

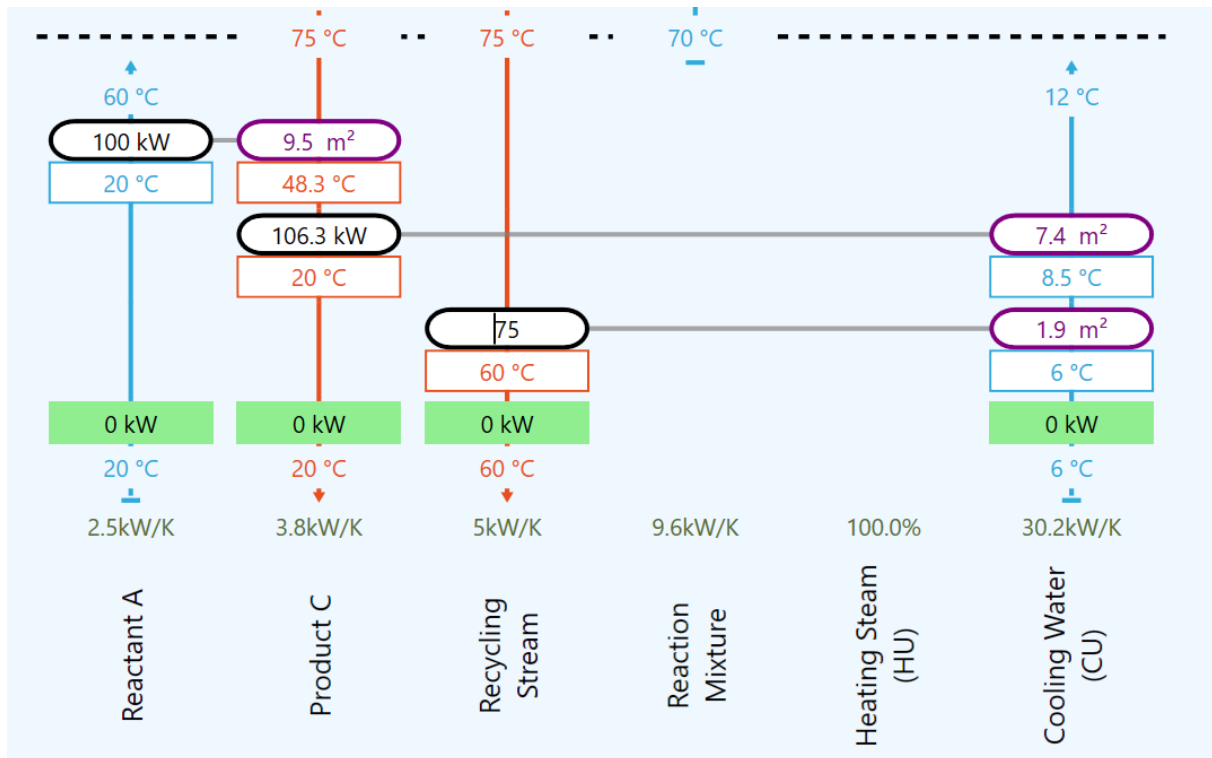

Figure 17: MER HEN for subsystem below the process pinch

Additional information: You can also remove a heat exchanger at any time:

- ☞ Right click on the connection line between the Heater/Coolers
- ☞ Select Remove Heat Exchanger Connection

Removing a Heater/Cooler:

- ☞ Right click on the Heater/Cooler
- ☞ Select Remove Heater/Cooler

Now consider the subsystem above the pinch and try to add the necessary heat exchangers on your own.

As you have surely noticed, the connection of the cold stream immediately above the pinch to both hot streams is not possible. The **Number Rule** is violated (see references on page 1). The cold stream Reaction Mixture to be heated ($CP = 9.6 \text{ kW/K}$) has to be split.

- ☞ Right click on the stream Reaction Mixture
- ☞ Select **Split Stream**

Start again with the stream with the largest heat capacity flow rate in the direction of the pinch. Connect the stream Recycling Stream ($CP = 5 \text{ kW/K}$) with one of the created stream branches from Reaction Mixture ($CP = 4.8 \text{ kW/K}$).

The connection is also not possible as the [CP-Rule](#) is now violated. In order to meet this requirement, the heat capacity flow rate of Reaction Mixture ($CP = 4.8 \text{ kW/K}$) must be the same or larger as that for Product C ($CP = 5 \text{ kW/K}$) (see references on page 1). Change the heat capacity flow rate of one of the process stream "Reaction Mixture" branch splits in the corresponding cell underneath the text of the stream name.

 Click on the cell

 Enter a heat capacity flow rate of $CP = 5.85 \text{ kW/K}$.

The connection between the streams is now possible. In order to ensure an isothermal mixture, the Tick Off Rule should not be applied until the Heater/Coolers are present and connected in both stream branches.

In order to heat up the second stream branch of process stream Reaction Mixture ($CP = 3.8 \text{ kW/K}$), connect it to the stream Product C ($CP = 3.8 \text{ kW/K}$). Before we place the remaining heaters, it is useful for reasons of construction to merge the split streams of the reaction mixture:

 Right click on the process stream Reaction Mixture (above the Heater/Coolers)

 Select [Merge Branches](#)

In order to handle the rule that two stream branches must be mixed isothermally (see references on page 1), the following can be done:

 Double click on the Heater/Cooler of the Reaction Mixture which the stream Product C is connected (Tick Off Rule)

 Similarly, apply the Tick Off Rule to the Heater/Cooler for the Reaction Mixture that is connected to the Recycling Stream.

Upon completion, the temperatures after the heat exchangers are identical and mix isothermally.

To complete the MER HEN, again connect the stream Reaction Mixture (after the merge) and the Recycling Stream and finally at the end the Reaction Mixture with the Hot Utility.

The table in the lower area of Figure 18 shows the energy and cost values calculated in [Step 8](#) as well as the highlighted data under [Design MER HEN](#). It can be seen that the target value for the thermal performance for heat recovery is achieved. The target values for the heat transfer area and the investment costs were also almost reached.

Note: The fact that we are able to achieve the energy and cost targets in this example is undoubtedly due to the simplicity of the chosen example. As a rule, it is important to find a compromise between the complexity of the heat exchanger network and the degree of energy and cost efficiency. For this, a so-called relaxed HEN can be created in [PinCH](#), for which the three pinch main rules are not strictly adhered to.

The complete MER-HEN should look as follows:

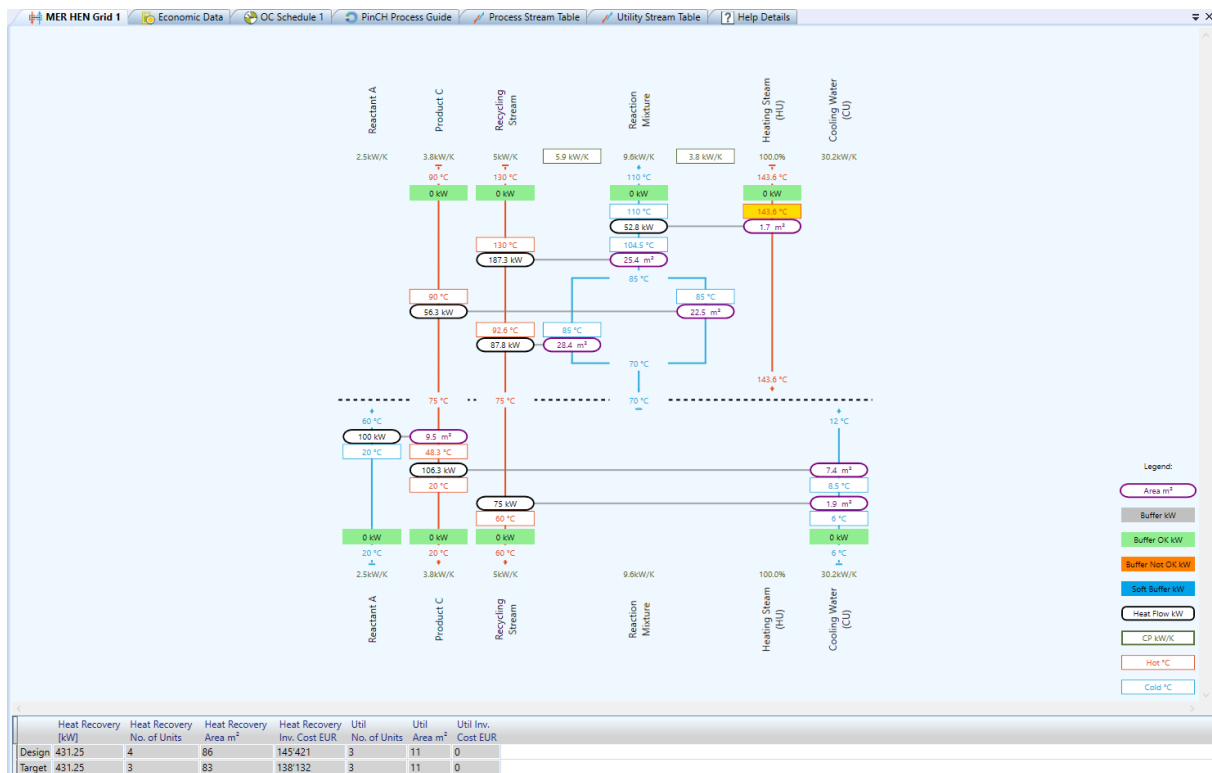

Figure 18: MER HEN Grid

This MER HEN Design is only an example. For each process, there are several possibilities to connect the streams in heat transfer.

Additional information: Driving Force Plot / HEX Details

If the HEN design HR investment costs differ strongly from the Target Results, this is due to the fact that non vertical heat transfer takes place (see references on page 1). To check this, we need to examine the Driving Force Plot of each heat exchanger. By double-clicking on the connection line between the Heater/Coolers (or right clicking on one of the Heater/Coolers and selecting Display HEX Details), you will be taken to a new menu, in which all the heat exchangers with all the necessary details required for interpretation and analysis are listed. Beneath the table is shown on the left side chart which plots T , $\Delta\dot{H}$ for the two individual streams which are coupled by the respective heat exchanger. On the right side of the heat exchanger the Driving Force / Temperature gradient is shown.

The Driving Force Plot shows the temperature difference in a heat exchanger as a function of the temperature change of the cold stream. The blue curve describes the target and the black the real driving force in individual heat exchangers.

If the two curves do not match, it is called a "criss-cross" heat exchanger. In doing so, too much or too little of the available driving forces are used, which leads to an increase or decrease of the required heat transfer surface.

Optimizing the HEN using the Driving Force Plot achieves a minimum heat transfer area. How-

ever, this method is often in contradiction with the tick off rule (double-click on the heat flow of a Heater/Cooler), which aims to maximize the amount of heat transferred. It is at the discretion of the engineer to find a suitable compromise.

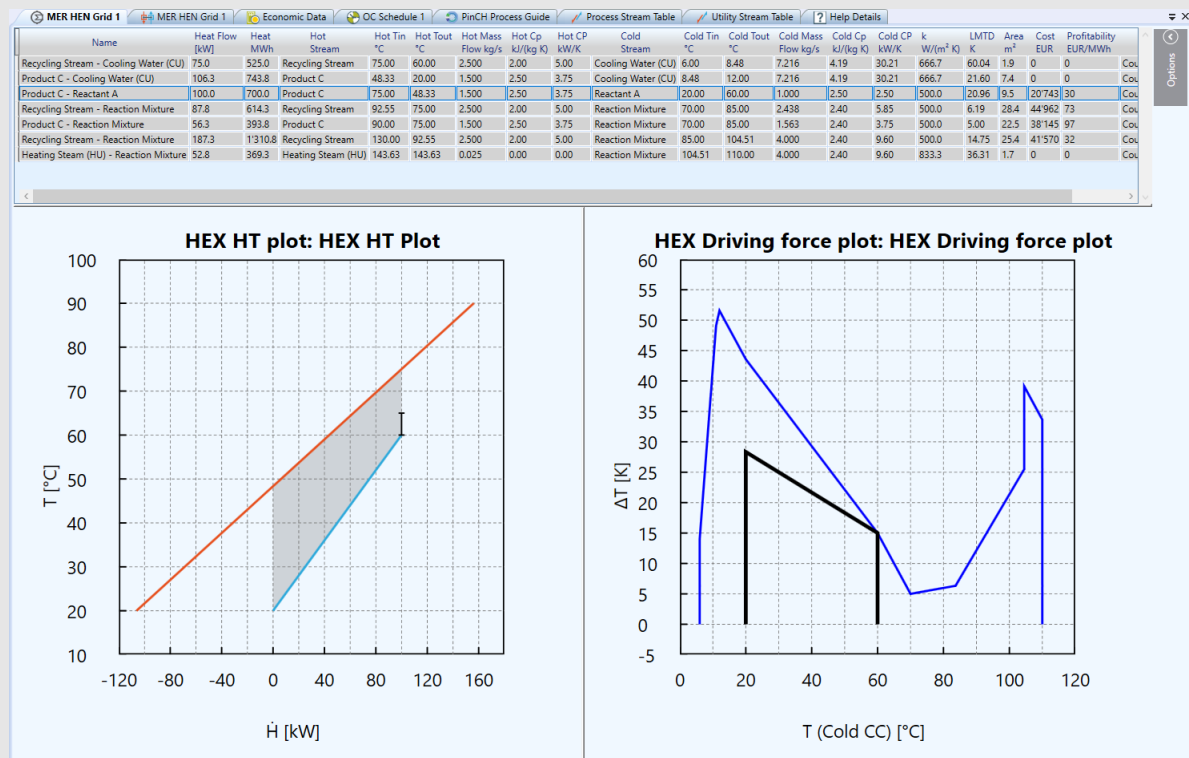

Figure 19: Driving Force Plot for the heat exchanger "Product C – Reactant A"

In order to optimize the Driving Force, the heat capacity flow rate CP of the respective process stream must be adjusted. This is only possible by introducing new splits or rebuilding the design (heat transfer to other streams than as determined before). In our example, the area target is almost achieved and therefore the Driving Force Plot is not used.

In the above corner on the right side of the picture are the HEX Options. Under these options the HEX-Typ can be changed (as Default is counter current HEX used) and the costs of the individual heat exchangers modified.

IV Optimized Process

If we transfer the created MER HEN to the process flow chart shown at the beginning of the tutorial, the following scheme can be derived for the optimized plant:

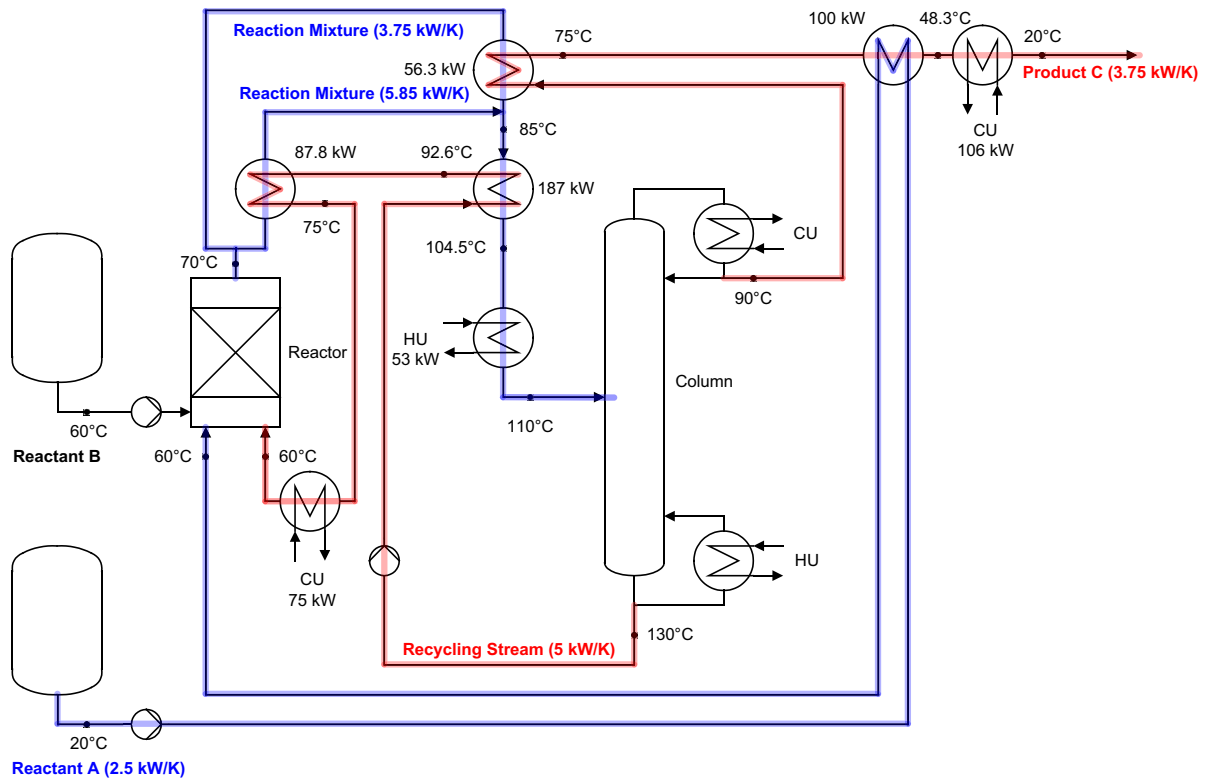

Figure 20: Process flow sheet of the optimized production plant

Through the new heat exchanger network in comparison to the existing process, we can save 84 % of the HU and 60 % of the CU and in total 210'770 €/a energy costs. Including depreciation of the investment cost, the yearly total costs of the optimized plant is approximately 131'000 €/a representing a reduction of 54 %.

Table 4: Comparison of the existing and optimized production plant

	Hot Utility		Cold Utility		Energy Cost	Inv. Cost	Yearly Total Cost
	[kW]	[MWh]	[kW]	[MWh]	[€/a]	[€]	[€/a]
Existing Design	326	2'282	456	3'192	287'420	0	287'420
Optimized Design	53	371	181	1'267	76'650	145'400	131'030
Savings	273	1'911	275	1'925	210'770	-145'421	156'390

Thank you for your time!

You are now familiar with the most elementary steps necessary to complete a pinch analysis with [PinCH](#). Please do not hesitate to contact us if you have any questions. The PinCH team of the Lucerne University of Applied Sciences and Arts and the Centre de Compétence PinCH Francophone of the School of Management and Engineering Vaud are available at your convenience. Please also note the option of coaching to assist with and ensure the quality of your pinch analyses. Learning by doing in this way has already proved to be an excellent experience on multiple occasions. In any case, we hope you have lots of fun and wish you every success with [PinCH](#). Thank you so much for taking the time to join us! For more information, please visit our website www.pinch-analyse.ch. You will find our contact details below.

Kind regards,

the PinCH team of the Lucerne University of Applied Science and Arts

English and German Contact:

Lucerne University of
Applied Sciences and Arts
Competence Center Thermal Energy
Systems and Process Engineering
Technikumstrasse 21
CH-6048 Horw
Prof Dr Beat Wellig
T +41 41 349 32 57
pinch@hslu.ch

French Contact:

Haute Ecole d'Ingénierie et de
Gestion du Canton de Vaud
Institut de Génie Thermique
Centre de compétence PinCH francophone
Avenue des Sports 20
CH-1401 Yverdon-les-Bains
Dr Pierre Krummenacher
T +41 24 557 61 54
pinch@heig-vd.ch



This work (hereinafter referred to as "Tutorial") is used to give an introduction to the [PinCH](#) software of Lucerne University of Applied Sciences and Arts. This Tutorial is available for free at www.pinch-analyse.ch. Commercial distribution is prohibited. Commercial use in training and further training courses, workshops, coaching sessions or similar events is prohibited. Distribution of derivative works based on this Tutorial is prohibited.